

# ZGSM-LGCD60WE

a Variety Purposes of Lighting. In Just one Luminaire.

100W HID Replacement



Dimming functions are supported by optional  
 † Three in One (1-10V DC or PWM Signal or Resistance)  
 † Timer - Contact ZGSM for Details

## Specifications

### Electrical Specifications:

Model No.	ZGSM-LGCD60WE
Nominal Wattage	65W
Nominal Voltage	AC 100-240V, 50/60Hz DC /
Maximum Current	AC 0.67A -120V, 0.33A -240V DC /
Optimal Operating Temperature	-40 °C to +50 °C
Power Factor (PF)	> 0.9
Driver Efficiency	> 90%

### Photometric Specifications:

Lumen Output	<sup>†</sup> Lumen tolerance +/- 5%
3000-4500K	5850 lm
5000-6500K	6175 lm
CRI	Ra >= 75
CCT	



### Mechanical Specifications:

IP Rating	IP65
Lifetime	50000 hours
Heat Radiator	Anodized Aluminum
Lens	PC
Fixture Dimension	395 x275 x190 mm 15.6 x10.8 x7.5 inches
Fixture Weight	5.8 kg /12.8 lbs

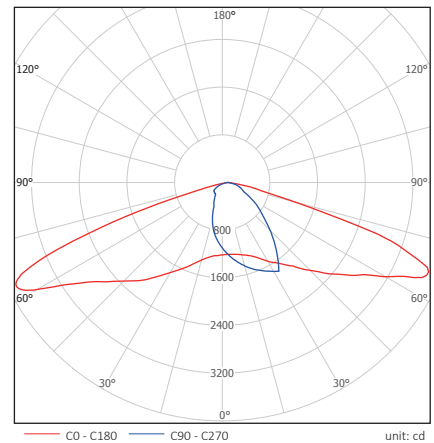
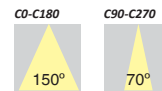
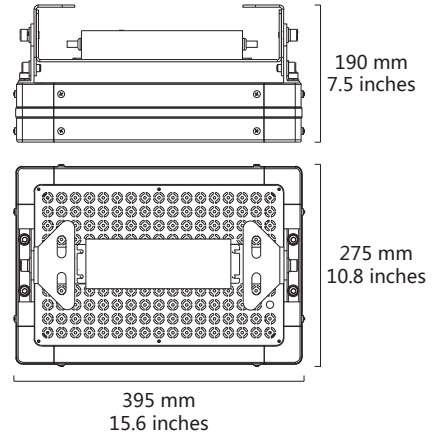

\*Photometric data based on 6000-6500K color temperature.

### Packing Type

1unit(s) /ctn.

### Packing Dimension

445 x325 x220 mm  
17.5 x12.8 x8.7 inches

### Packing Weight

7.0 kg /15.4 lbs



www.zgsm-china.com

