

ZGSM-LGCD30WE

High Performance Surface Mounted LED High Bay Light

70W HID Replacement



Dimming functions are supported by optional
 † Three in One (1-10V DC or PWM Signal or Resistance)
 † Timer - Contact ZGSM for Details

Specifications

Electrical Specifications:

Model No.	ZGSM-LGCD30WE
Nominal Wattage	35W
Nominal Voltage	AC 100-240V, 50/60Hz DC /
Maximum Current	AC 0.36A -120V, 0.18A -240V DC /
Optimal Operating Temperature	-40 °C to +50 °C
Power Factor (PF)	> 0.9
Driver Efficiency	> 90%

Photometric Specifications:

Lumen Output	†Lumen tolerance +/- 5%
3000-4500K	3150 lm
5000-6500K	3325 lm
CRI	Ra >= 75
CCT	

Mechanical Specifications:

IP Rating	IP65
Lifetime	50000 hours
Heat Radiator	Anodized Aluminum
Lens	Clear PC
Fixture Dimension	395 x190 x190 mm 15.6 x7.5 x7.5 inches
Fixture Weight	4.2 kg /9.3 lbs

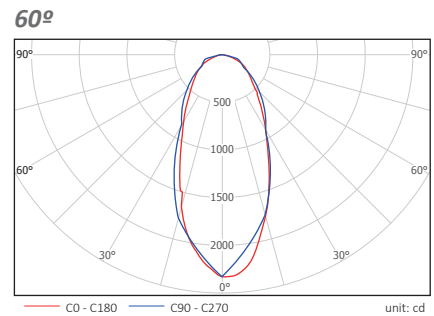
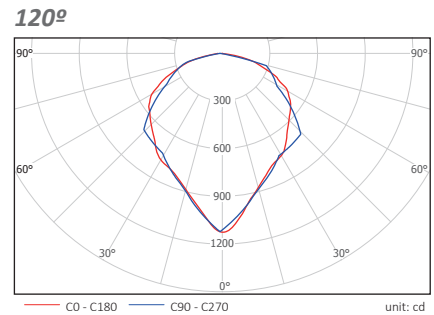
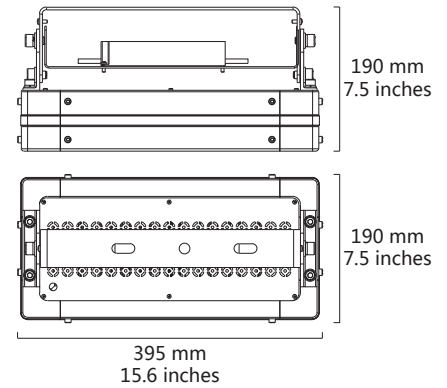

*Photometric data based on 6000-6500K color temperature.

Packing Type

1unit(s) /ctn.

Packing Dimension

445 x240 x220 mm
17.5 x9.4 x8.7 inches

Packing Weight

5.2 kg /11.5 lbs



www.zgsm-china.com

