

ZGSM-LQD90WA

Easy Mounting LED Recessed Light with IP65 Rating

150W HID Replacement



Dimming functions are supported by optional
 † Three in One (1-10V DC or PWM Signal or Resistance)
 † Timer - Contact ZGSM for Details

Specifications

Electrical Specifications:

Model No.	ZGSM-LQD90WA
Nominal Wattage	100W
Nominal Voltage	AC 100-240V, 50/60Hz DC /
Maximum Current	AC 1.03A -120V, 0.51A -240V DC /
Optimal Operating Temperature	-40 °C to +50 °C
Power Factor (PF)	> 0.9
Driver Efficiency	> 90%

Photometric Specifications:

Lumen Output	†Lumen tolerance +/- 5%
3000-4500K	9000 lm
5000-6500K	9500 lm
CRI	Ra >= 75
CCT	



Mechanical Specifications:

IP Rating	IP65
Lifetime	50000 hours
Heat Radiator	Anodized Aluminum
Lens	Clear PC
Fixture Dimension	365 x330 x130 mm 14.4 x13.0 x5.1 inches
Fixture Weight	6.7 kg /14.8 lbs

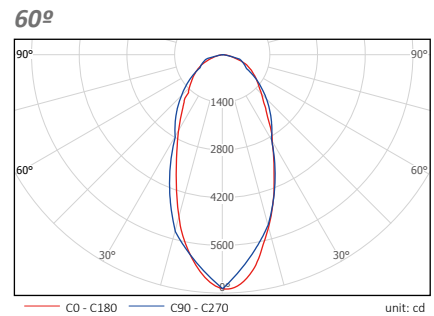
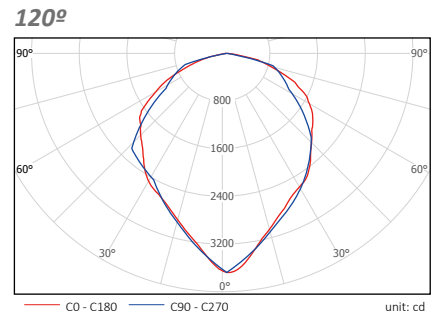
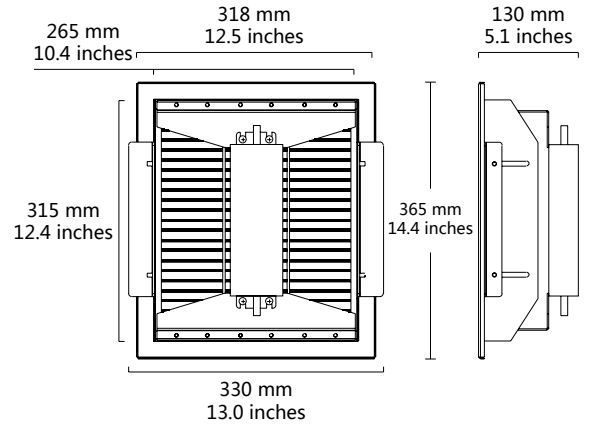

*Photometric data based on 6000-6500K color temperature.

Packing Type

1unit(s) /ctn.

Packing Dimension

415 x365 x195 mm
16.3 x14.4 x7.7 inches

Packing Weight

8.7 kg /19.2 lbs



www.zgsm-china.com

