

ZGSM-LQD60WA

Easy Mounting LED Recessed Light with IP65 Rating

100W HID Replacement



Dimming functions are supported by optional
 † Three in One (1-10V DC or PWM Signal or Resistance)
 † Timer - Contact ZGSM for Details

Specifications

Electrical Specifications:

Model No.	ZGSM-LQD60WA
Nominal Wattage	65W
Nominal Voltage	AC 100-240V, 50/60Hz DC /
Maximum Current	AC 0.67A -120V, 0.33A -240V DC /
Optimal Operating Temperature	-40 °C to +50 °C
Power Factor (PF)	> 0.9
Driver Efficiency	> 90%

Photometric Specifications:

Lumen Output	†Lumen tolerance +/- 5%
3000-4500K	5850 lm
5000-6500K	6175 lm
CRI	Ra >= 75
CCT	



Mechanical Specifications:

IP Rating	IP65
Lifetime	50000 hours
Heat Radiator	Anodized Aluminum
Lens	Clear PC
Fixture Dimension	365 x264 x130 mm 14.4 x10.4 x5.1 inches
Fixture Weight	4.7 kg /10.4 lbs

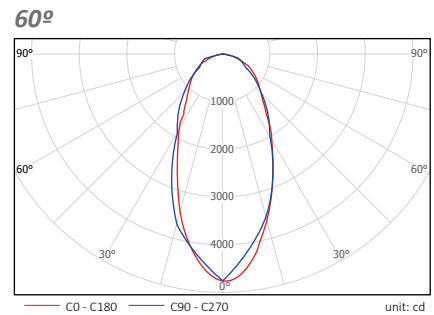
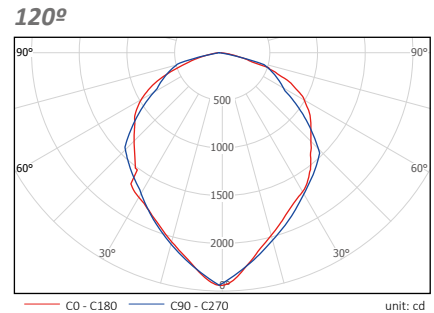
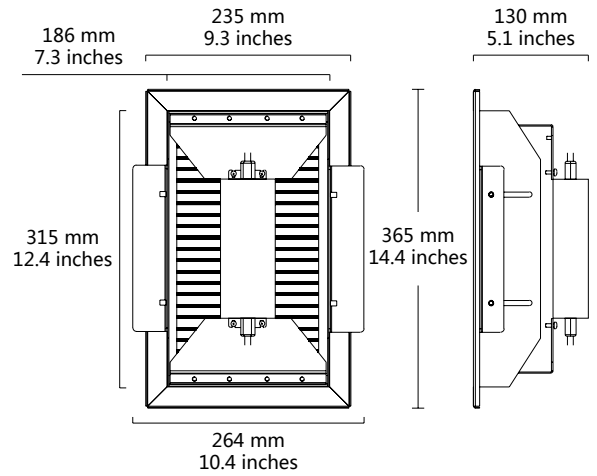

*Photometric data based on 6000-6500K color temperature.

Packing Type

1 unit(s) /ctn.

Packing Dimension

415 x285 x195 mm
16.3 x11.2 x7.7 inches

Packing Weight

6.7 kg /14.8 lbs



www.zgsm-china.com

